

JRG Valves

LegioStop

Hygienically flawless and permanently smooth-running Y-type and straight seat valves



New custom-fit insulating shells for Y-type valves



JRG LegioStop

Structure and function

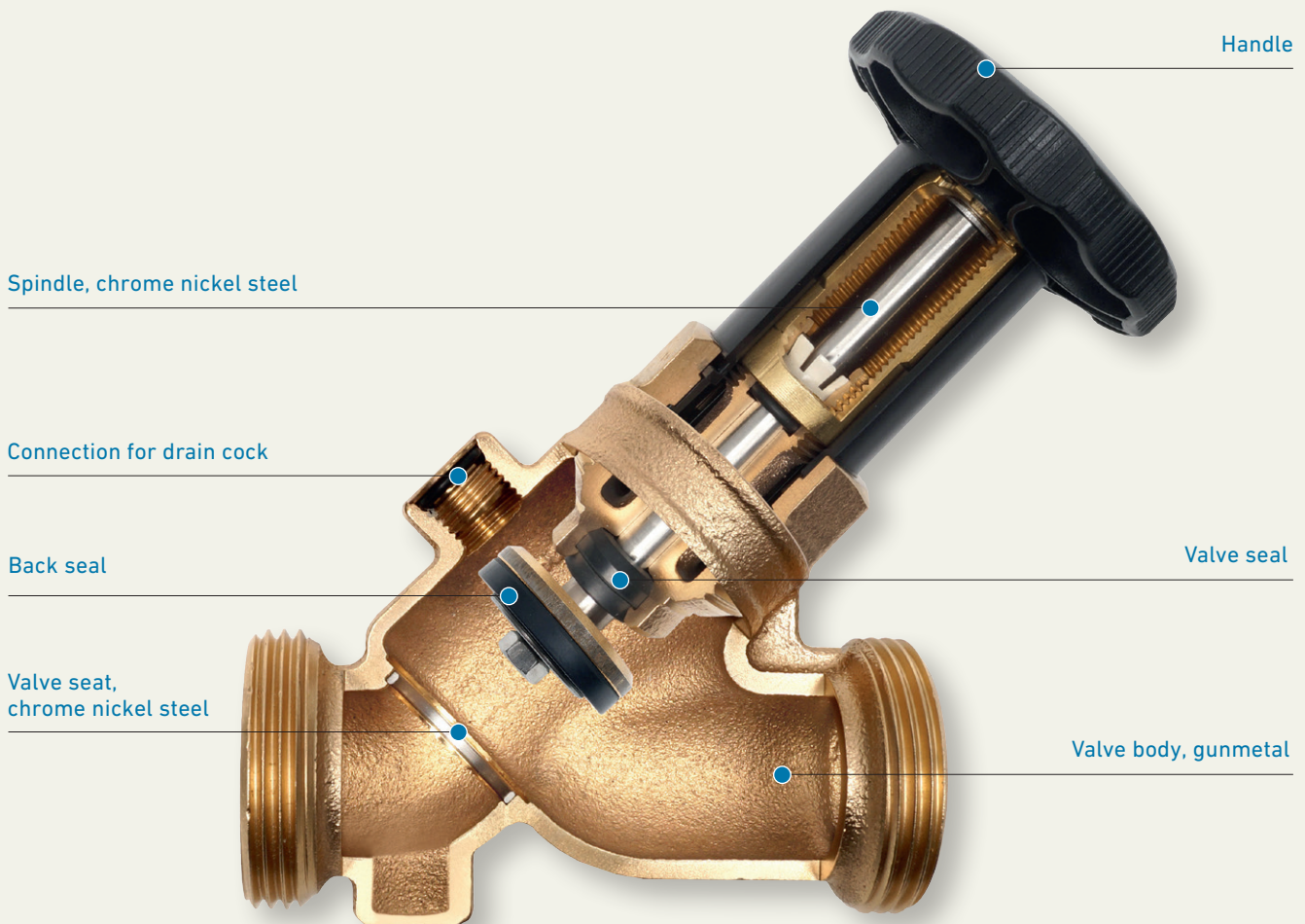

The LegioStop globe valves are identical in design

Why a new shut-off valve?

Drinking water is not a synthetically made hydraulic medium - but a natural product that, for reasons of hygiene, is only minimally altered.

Unfortunately, the natural occurring minerals in the water can precipitate out as crusts on taps, valves and on the linings of pipe walls. This can, in turn promote corrosion as well the growth of bacterial biofilms e.g. Legionella.

The JRG LegioStop shut-off valve was developed in order to rule out the possibility of malfunctions and to meet today's hygiene requirements (no dead spaces). In combination with the zero dead space piping systems from JRG, the result is a drinking water piping system completely free of dead spaces!

The LegioStop design guarantees continuous smooth operation of the valves. The multiple seal in the valve bonnet prevents the medium from penetrating the mechanics and thereby impairing the functionality of the valve and hygiene of the medium. The valve stem and the valve seat are made of chrome nickel steel and are therefore highly resistant to corrosion and erosion. The housing is made of gunmetal. The combination of these properties makes LegioStop valves a durable and reliable component of the drinking water installation.

+ Benefits of JRG LegioStop

Permanently smooth-running

The LegioStop design guarantees a strict separation of medium and mechanical parts and ensures the valve remains functional at all times

No dead space

The valve is completely flushed to maintain the hygiene of the medium

Valve seat and valve rod made of chrome nickel steel

The materials used for the valve are highly resistant to corrosion and erosion and ensure the long service life and functionality of the fitting

Valve position is visible and tangible

The user can quickly and easily determine the position of the valve (open/closed) via the extending spindle in the handwheel

Interchangeable medium marker plate

The media used can be easily assigned using the interchangeable marker plates in the handwheel

For 10 years warranty for Y-types valves

Performance chart Y-type valves

- 1 Pressure loss
- 2 Volumetric flow rate

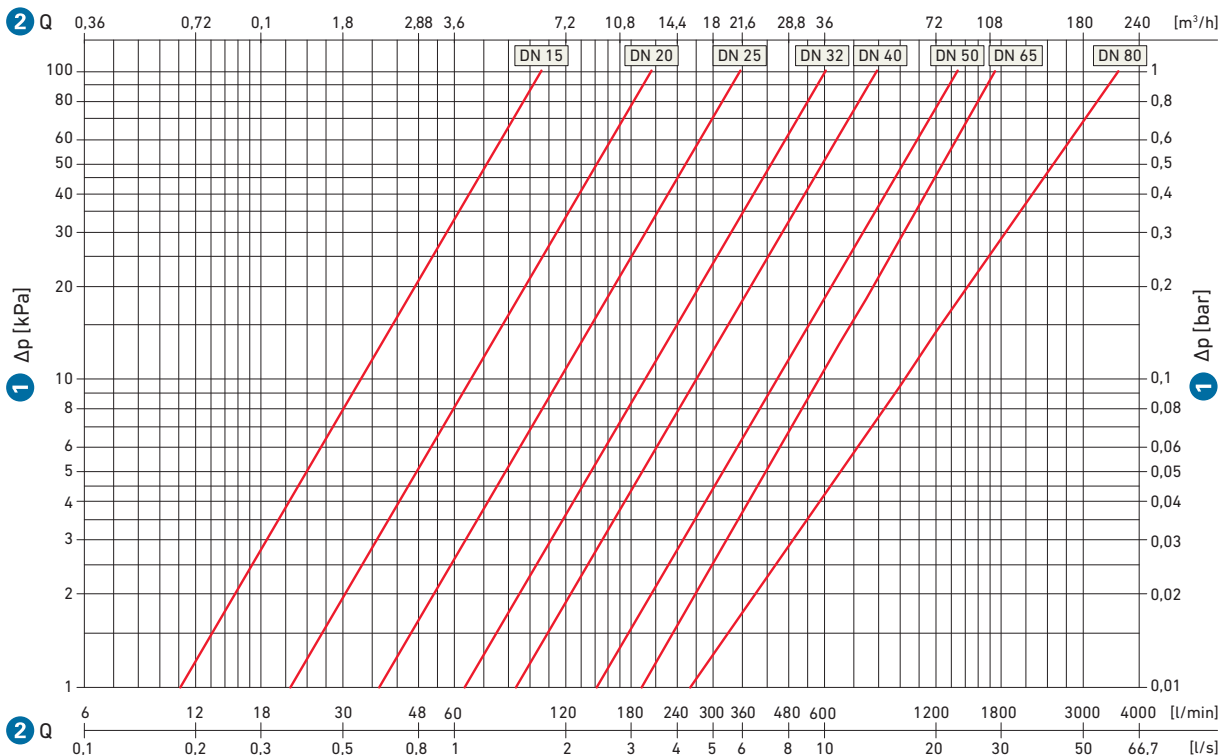

JRG LegioStop

Performance chart KRV lockable

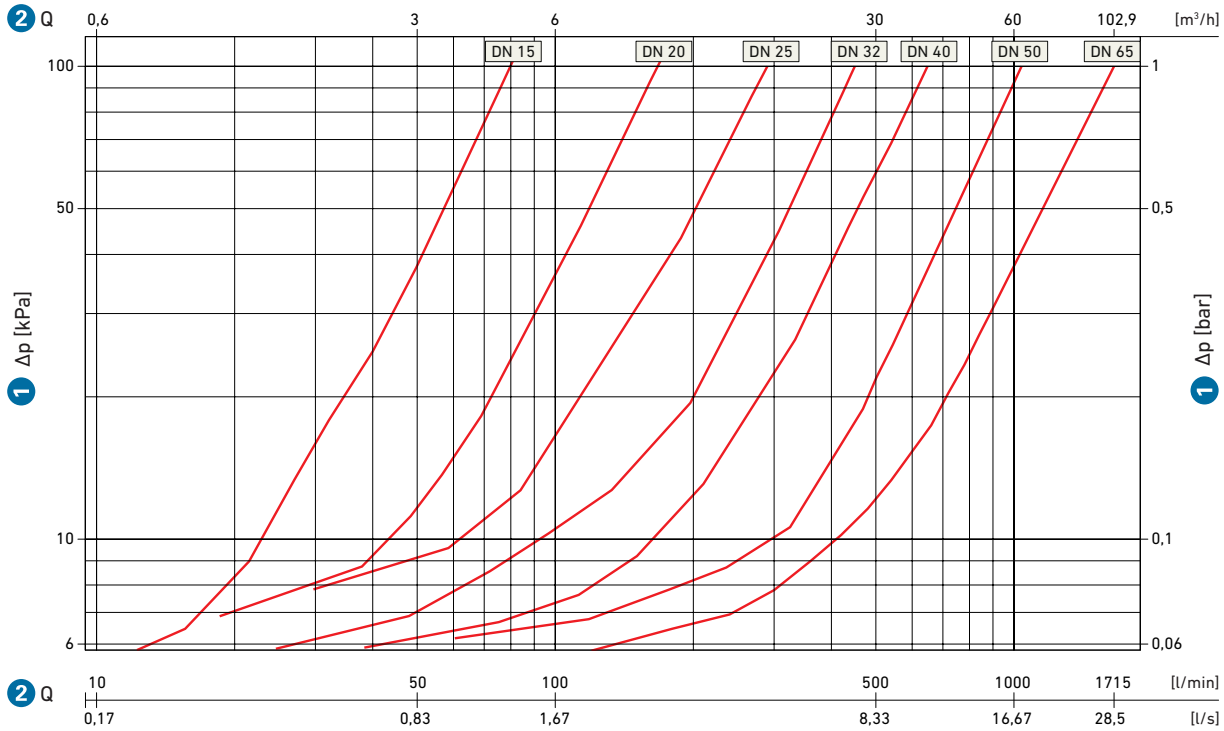

Performance chart Straight seat valves

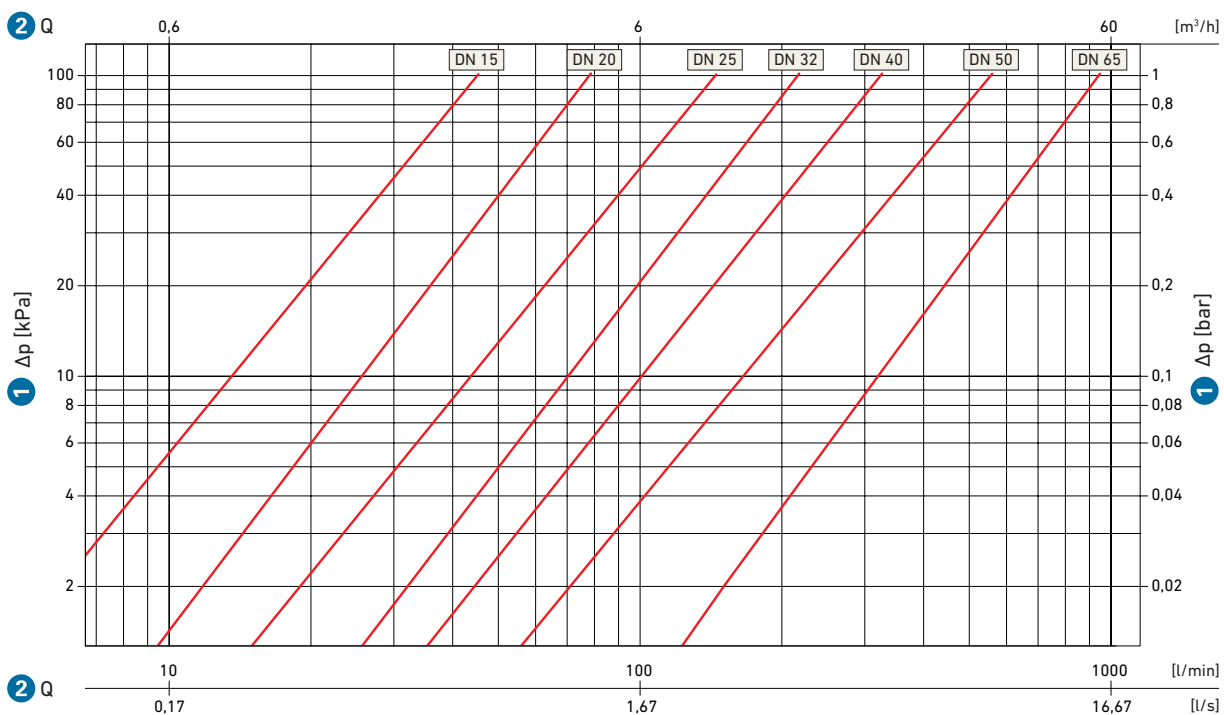

JRG LegioStop Insulation

The precisely fitting JRG insulating shells can further limit heat loss from the hot water pipe, thereby saving energy. In addition, the insulating shells help improve drinking water hygiene by reducing the heating of the cold water pipe. The insulating shells can be quickly and precisely installed thanks to the integrated closure.

- Temperature: max. 110°C
- Thermal conductivity: 0.035 W/mK (in accordance with EN 12667)
- Building material class: B2 (in accordance with DIN 4102) or E (in accordance with EN 13501-1)

+ Benefits

Best possible insulation values

Protection against heat loss from the hot water installation and heating up of the cold water installation

Fast, simple installation

The insulating shells are a perfect fit and have an integrated closure

Reusability

The insulating shells can be removed for maintenance or repair purposes and refitted afterwards









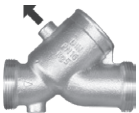

Sustainability

The material EPP (expanded polypropylene) is 100% recyclable





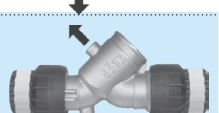



JRG LegioStop program overview

with SVGW/DVGM approval

		SSV	Upper part KRV	RV
Type	SSV Body Dim. 1/2-3	 5290 > 5045 > 5046	 5295 > 5047 closable	 1628
Slanted seat valve range 1		5211 > 5010 > 5011	-	-
Mapress Slanted seat valve with unions range 1		5213 > 5013	-	-
Optipress/Profipress/Sanpress Slanted seat valve with unions range 1		5234 > 5074	-	-
Back flow inhibitor with female thread		-	5266 > 5065 > 5066	1610 > 1640 > 1641
Back flow inhibitor range 1		-	5281 > 5080 > 5081 > 5286	1611 > 1643
Mapress Back flow inhibitor range 1 with unions		-	5283 > 5083	-
Optipress/Profipress/Sanpress Back flow inhibitor range 1 with unions		-	5284	-
Fittings with adapter MT		5222 > 4760 > 4762	5262	1612
Fittings with push fit connection		5225 > 5005 > 5025 > 5026	5265	1615

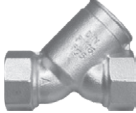
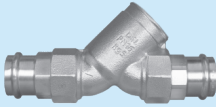
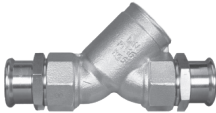
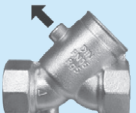
JRG LegioStop program overview

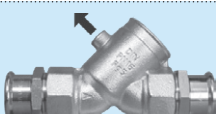
with SVGW/DVGM approval

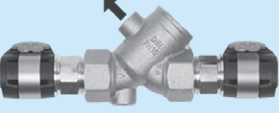
		Upper part SSV	Upper part KRV	Upper part RV
Type	SSV Body Dim. 1/2-2	 5290 > 5045 > 5046	 5295 > 5047 lockable	 1628
Slanted seat valve		5200 > 5000 > 5050 > 5250	-	-
Optipress/Profipress/ Sanpress Slanted seat valve with adapter		5207 > 5007	-	-
Mapress Slanted seat valve with adapter		5208 > 5008	-	-
Slanted seat valve		5221 > 5020 > 5031 > 5256 > 5021 > 5056 > 5030 > 5231	-	-
Optipress/Profipress/ Sanpress Slanted seat valve with adapter		5227 > 5027	-	-
Mapress Slanted seat valve with adapter		5228 > 5028	-	-
Mepla Slanted seat valve with adapter		5229 > 5029	-	-
FlowFit Slanted seat valve with adapter		5239	-	-

Note: All upper parts fit earlier JRG valve bodies and also other valve bodies (DIN 3502).
The 5395 upper parts fit the straight seat valves.

Product range Y-type valves



JRG LegioStop Y-type valve gunmetal

- Description: free of water pockets and maintenance free top, non rising handwheel with optical position indicator, valve seat and valve stem made of stainless steel
- Temperature: max. 90°C
- Material: gunmetal, stainless steel, EPDM, plastic
- Connection: female thread

GN (inch)	Size (inch)	DN (mm)	JRG Code	GF Code	Weight (kg)
½	½	15	5200.240	350 895 600	0.345
¾	¾	20	5200.320	350 895 601	0.500
1	1	25	5200.400	350 895 602	0.875
1 ¼	1 ¼	32	5200.480	350 895 603	1.268
1 ½	1 ½	40	5200.560	350 895 604	1.600
2	2	50	5200.640	350 895 605	2.500

d1 Rp (inch)	d2 G (inch)	d4 (mm)	h (mm)	l1 (mm)	l2 (mm)	PN (bar)	z1 (mm)	z2 (mm)
½	½	53	87	65	46	16	10	27
¾	¾	53	105	75	56	16	12	33
1	1	60	117	90	59	16	15	40
1 ¼	1 ¼	70	130	110	59	16	19	52
1 ½	1 ½	90	148	120	67	16	20	61
2	2	90	169	150	67	16	23	77

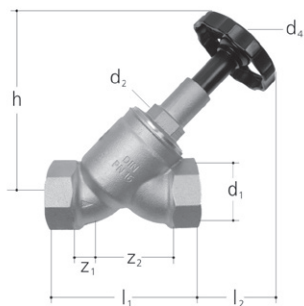

JRG LegioStop Y-type valve gunmetal

- Description: free of water pockets and maintenance free top, rising handwheel, valve seat and valve stem made of stainless steel
- Temperature: max. 90°C
- Material: gunmetal, stainless steel, EPDM, metal
- Connection: female thread

GN (inch)	Size (inch)	DN (mm)	JRG Code	GF Code	Weight (kg)
2 ½	2 ½	65	5200.720	350 818 706	4.200
3	3	80	5200.800	350 818 806	5.750

d1 Rp (inch)	d2 G (inch)	d4 (mm)	h (mm)	l1 (mm)	l2 (mm)	PN (bar)	z1 (mm)	z2 (mm)
2 ½	2 ½	120	260	180	132	16	22	98
3	3	120	277	210	127	16	27	117

Product range Y-type valves

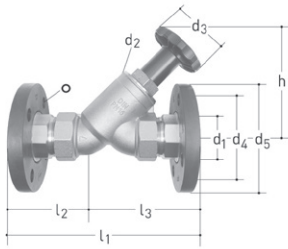

JRG LegioStop Y-type valve with flanges gunmetal

- Description: free of water pockets and maintenance free top, non rising handwheel with optical position indicator, valve seat and valve stem made of stainless steel
- Temperature: max. 90°C
- Material: gunmetal, stainless steel, EPDM, plastic
- Connection: flange

DN (mm)	d (mm)	JRG Code	GF Code	Weight (kg)
25	25	5204.025	350 895 726	2.530
32	32	5204.032	350 895 727	3.500
40	40	5204.040	350 895 728	4.540
50	50	5204.050	350 895 729	7.080

DN (mm)	d1 (mm)	d2 G (inch)	d3 (mm)	d4 (mm)	d5 (mm)	h (mm)	l1 (mm)	l2 (mm)	l3 (mm)	PN (bar)	○
25	25	1	60	85	115	117	188	82	107	16	4x14
32	32	1 ¼	70	100	140	130	213	90	123	16	4x18
40	40	1 ½	90	110	150	148	229	94	135	16	4x18
50	50	2	90	125	165	169	262	104	158	16	4x18

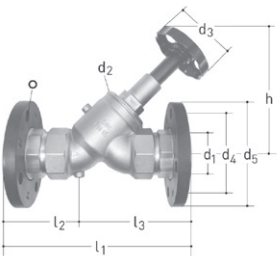

JRG LegioStop Y-type valve with flanges gunmetal

- Description: free of water pockets and maintenance free top, rising handwheel, valve seat and valve stem made of stainless steel
- Temperature: max. 90°C
- Material: gunmetal, stainless steel, EPDM, metal
- Connection: flange

DN (mm)	d (mm)	JRG Code	GF Code	Weight (kg)
65	65	5204.065	350 895 730	10.340
80	80	5204.080	350 895 731	13.020

DN (mm)	d1 (mm)	d2 G (inch)	d3 (mm)	d4 (mm)	d5 (mm)	h (mm)	l1 (mm)	l2 (mm)	l3 (mm)	PN (bar)	○
65	65	2 ½	120	145	185	260	296	110	187	16	4x18
80	80	3	120	160	200	277	333	122	212	16	8x18

Product range Y-type valves

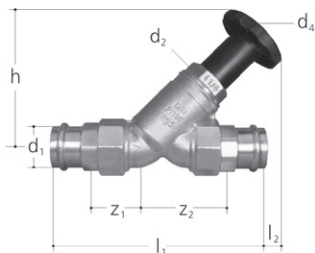

JRG LegioStop Y-type valve Optipress / Sanpress gunmetal

- Description: free of water pockets and maintenance free top, non rising handwheel with optical position indicator, valve seat and valve stem made of stainless steel
- Temperature: max. 90°C
- Material: gunmetal, stainless steel, EPDM, plastic
- Connection: Optipress / Sanpress

d (mm)	DN (mm)	JRG Code	GF Code	Weight (kg)
15	12	5207.015	350 895 612	0.420
18	15	5207.018	350 895 613	0.430
22	20	5207.022	350 895 614	0.650
28	25	5207.028	350 895 615	1.100
35	32	5207.035	350 895 616	1.540
42	40	5207.042	350 895 617	2.508
54	50	5207.054	350 895 618	3.570

d1 (mm)	d2 G (inch)	d4 (mm)	h (mm)	l1 (mm)	l2 (mm)	z1 (mm)	z2 (mm)	PN (bar)
15	½	53	87	131	13	33	50	16
18	½	53	87	131	13	33	50	16
22	¾	53	105	146	21	39	60	16
28	1	60	117	166	21	47	72	16
35	1 ¼	70	130	196	16	56	89	16
42	1 ½	90	148	226	14	57	98	16
54	2	90	169	264	10	59	113	16

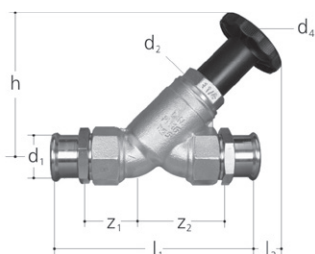

JRG LegioStop Y-type valve Mapress gunmetal

- Description: free of water pockets and maintenance free top, non rising handwheel with optical position indicator, valve seat and valve stem made of stainless steel
- Temperature: max. 90°C
- Material: gunmetal, brass, EPDM, plastic
- Connection: Mapress

d (mm)	DN (mm)	JRG Code	GF Code	Weight (kg)
15	12	5208.015	350 895 619	0.440
18	15	5208.018	350 895 620	0.450
22	20	5208.022	350 895 621	0.660
28	25	5208.028	350 895 622	1.080
35	32	5208.035	350 895 623	1.570
42	40	5208.042	350 895 624	2.040
54	50	5208.054	350 895 625	3.230

d1 (mm)	d2 G (inch)	d4 (mm)	h (mm)	l1 (mm)	l2 (mm)	z1 (mm)	z2 (mm)	PN (bar)
15	½	53	87	123	17	33	50	16
18	½	53	87	125	16	33	51	16
22	¾	53	105	133	27	35	56	16
28	1	60	117	152	28	40	66	16
35	1 ¼	70	130	178	25	46	80	16
42	1 ½	90	148	196	29	48	89	16
54	2	90	169	282	21	79	133	16

Product range Y-type valves

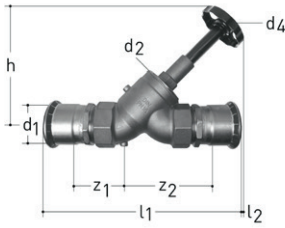

JRG LegioStop Y-type valve Mapress gunmetal

- Description: free of water pockets and maintenance free top, rising handwheel, valve seat and valve stem made of stainless steel
- Temperature: max. 90°C
- Material: gunmetal, stainless steel, EPDM, metal
- Connection: Mapress

d (mm)	DN (mm)	JRG Code	GF Code	Weight (kg)
76.1	65	5208.076	350 818 723	5.760
88.9	80	5208.088	350 818 818	8.155

d (mm)	DN (mm)	d1 (mm)	d2 G (inch)	d4 (mm)	h (mm)	l1 (mm)	l2 (mm)	z1 (mm)	z2 (mm)	PN (bar)
76.1	65	76	2 ½	120	260	365	39	92	168	16
88.9	80	89	3	120	277	425	20	108	198	16

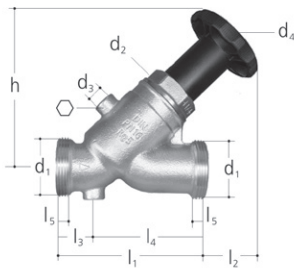

JRG LegioStop Y-type valve gunmetal

- Description: free of water pockets and maintenance free top, non rising handwheel with optical position indicator, valve seat and valve stem made of stainless steel
- Temperature: max. 90°C
- Material: gunmetal, stainless steel, EPDM, plastic
- Connection: male thread

Size (inch)	DN (mm)	JRG Code	GF Code	Weight (kg)
½	15	5211.015	350 895 651	0.350
¾	20	5211.020	350 895 652	0.530
1	25	5211.025	350 895 653	0.840
1 ¼	32	5211.032	350 895 654	1.130
1 ½	40	5211.040	350 895 655	1.620
2	50	5211.050	350 895 656	2.330

d1 G (inch)	d2 G (inch)	d3 Rp (inch)	d4 (mm)	h (mm)	l1 (mm)	l2 (mm)	l3 (mm)	l4 (mm)	l5 (mm)	PN (bar)	○
¾	½	¼	53	87	75	35	24	52	6	16	6
1	¾	¼	53	105	87	42	24	63	7	16	6
1 ¼	1	¼	60	117	99	42	24	75	8	16	6
1 ½	1 ¼	¼	70	130	118	42	30	89	9	16	6
1 ¾	1 ½	¼	90	148	130	48	31	100	10	16	6
2 ¾	2	¼	90	169	155	49	35	120	11	16	6

Product range Y-type valves

JRG LegioStop Y-type valve gunmetal

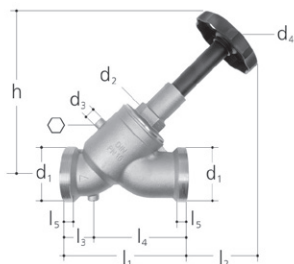

- Description: free of water pockets and maintenance free top, rising handwheel, valve seat and valve stem made of stainless steel
- Temperature: max. 90°C
- Material: gunmetal, stainless steel, EPDM, metal
- Connection: male thread

Size (inch)	DN (mm)	JRG Code	GF Code	Weight (kg)
2 ½	65	5211.065	351 057 004	4.060
3	80	5211.080	351 057 104	5.170

d1 G (inch)	d2 G (inch)	d3 Rp (inch)	d4 (mm)	h (mm)	l1 (mm)	l2 (mm)	l3 (mm)	l4 (mm)	l5 (mm)	PN (bar)	⊙
3	2 ½	¼	120	260	190	113	43	147	15	16	6
3 ½	3	¼	120	277	215	122	60	155	16	16	6

JRG LegioStop Y-type valve with screw connections Mapress gunmetal

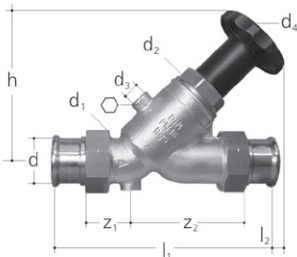

- Description: free of water pockets and maintenance free top, non rising handwheel with optical position indicator, valve seat and valve stem made of stainless steel
- Temperature: max. 90°C
- Material: gunmetal, stainless steel, EPDM, plastic
- Connection: Mapress

d (mm)	DN (mm)	JRG Code	GF Code	Weight (kg)
15	12	5213.015	350 895 663	0.510
18	15	5213.018	350 895 664	0.500
22	20	5213.022	350 895 665	0.740
28	25	5213.028	350 895 666	1.180
35	32	5213.035	350 895 667	1.500
42	40	5213.042	350 895 668	2.025
54	50	5213.054	350 895 669	3.170

d (mm)	DN (mm)	d1 G (inch)	d2 G (inch)	d3 Rp (inch)	d4 (mm)	h (mm)	l1 (mm)	l2 (mm)	z1 (mm)	z2 (mm)	PN (bar)	⊙
15	12	¾	½	¼	53	87	136	5	35	63	16	6
18	15	¾	½	¼	53	87	136	5	35	63	16	6
22	20	1	¾	¼	53	105	150	10	35	74	16	6
28	25	1 ¼	1	¼	60	117	170	7	37	87	16	6
35	32	1 ½	1 ¼	¼	70	130	195	4	43	102	16	6
42	40	1 ¾	1 ½	¼	90	148	215	6	44	113	16	6
54	50	2 ¾	2	¼	90	169	252	2	49	134	16	6

Product range Y-type valves

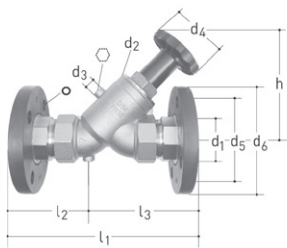

JRG LegioStop Y-type valve with flanges gunmetal

- Description: free of water pockets and maintenance free top, non rising handwheel with optical position indicator, valve seat and valve stem made of stainless steel
- Temperature: max. 90°C
- Material: gunmetal, stainless steel, EPDM, plastic
- Connection: flange

DN (mm)	d (mm)	JRG Code	GF Code	Weight (kg)
25	25	5220.025	350 895 526	2.550
32	32	5220.032	350 895 527	3.520
40	40	5220.040	350 895 528	4.560
50	50	5220.050	350 895 529	7.090

DN (mm)	d1 (mm)	d2 G (inch)	d3 Rp (inch)	d4 (mm)	d5 (mm)	d6 (mm)	h (mm)	l1 (mm)	l2 (mm)	l3 (mm)	PN (bar)	○	◇
25	25	1	¼	60	85	115	117	188	82	107	16	4x14	6
32	32	1 ¼	¼	70	100	140	130	213	90	123	16	4x18	6
40	40	1 ½	¼	90	110	150	148	229	94	135	16	4x18	6
50	50	2	¼	90	125	165	169	262	104	158	16	4x18	6

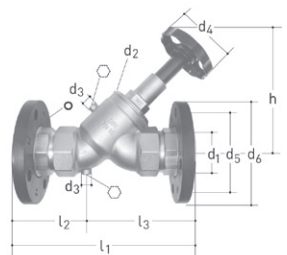

JRG LegioStop Y-type valve with flanges gunmetal

- Description: free of water pockets and maintenance free top, rising handwheel, valve seat and valve stem made of stainless steel
- Temperature: max. 90°C
- Material: gunmetal, stainless steel, EPDM, metal
- Connection: flange

DN (mm)	d (mm)	JRG Code	GF Code	Weight (kg)
65	65	5220.065	350 895 936	10.360
80	80	5220.080	350 895 937	13.030

DN (mm)	d1 (mm)	d2 G (inch)	d3 Rp (inch)	d4 (mm)	d5 (mm)	d6 (mm)	h (mm)	l1 (mm)	l2 (mm)	l3 (mm)	PN (bar)	○	◇
65	65	2 ½	¼	120	145	185	260	296	110	187	16	4x18	6
80	80	3	¼	120	160	200	277	333	122	212	16	8x18	6

Product range Y-type valves

JRG LegioStop Y-type valve gunmetal

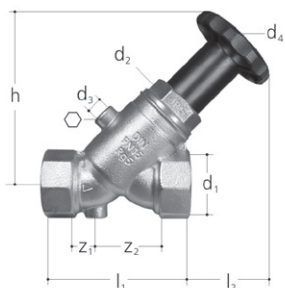

- Description: free of water pockets and maintenance free top, non rising handwheel with optical position indicator, valve seat and valve stem made of stainless steel
- Temperature: max. 90°C
- Material: gunmetal, stainless steel, EPDM, plastic
- Connection: female thread

GN (inch)	Size (inch)	DN (mm)	JRG Code	GF Code	Weight (kg)
½	½	15	5221.240	350 895 633	0.370
¾	¾	20	5221.320	350 895 634	0.554
1	1	25	5221.400	350 895 635	0.890
1 ¼	1 ¼	32	5221.480	350 895 636	1.280
1 ½	1 ½	40	5221.560	350 895 637	1.610
2	2	50	5221.640	350 895 638	2.520

d1 Rp (inch)	d2 G (inch)	d3 Rp (inch)	d4 (mm)	h (mm)	l1 (mm)	l2 (mm)	z1 (mm)	z2 (mm)	PN (bar)	⊙
½	½	¼	53	87	65	46	10	27	16	6
¾	¾	¼	53	105	75	56	12	33	16	6
1	1	¼	60	117	90	59	15	40	16	6
1 ¼	1 ¼	¼	70	130	110	59	19	52	16	6
1 ½	1 ½	¼	90	148	120	67	20	61	16	6
2	2	¼	90	169	150	67	23	77	16	6

JRG LegioStop Y-type valve gunmetal

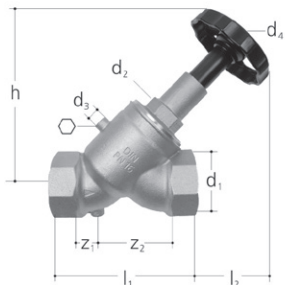

- Description: free of water pockets and maintenance free top, rising handwheel, valve seat and valve stem made of stainless steel
- Temperature: max. 90°C
- Material: gunmetal, stainless steel, EPDM, metal
- Connection: female thread

GN (inch)	Size (inch)	DN (mm)	JRG Code	GF Code	Weight (kg)
2 ½	2 ½	65	5221.720	350 818 707	4.220
3	3	80	5221.800	350 818 807	5.690

d1 Rp (inch)	d2 G (inch)	d3 Rp (inch)	d4 (mm)	h (mm)	l1 (mm)	l2 (mm)	z1 (mm)	z2 (mm)	PN (bar)	⊙
2 ½	2 ½	¼	120	260	180	132	22	98	16	6
3	3	¼	120	277	210	127	27	117	16	6

Product range Y-type valves

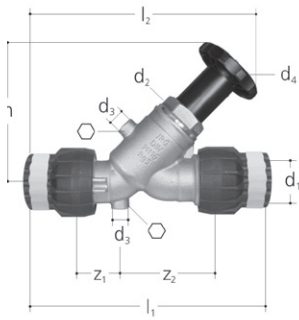

JRG Sanipex MT LegioStop Y-type valve gunmetal

- Description: free of water pockets and maintenance free top, non rising handwheel with optical position indicator, valve seat and valve stem made of stainless steel
- Temperature: max. 90°C
- Material: gunmetal, stainless steel, EPDM, plastic
- Connection: JRG Sanipex MT

d (mm)	DN (mm)	JRG Code	GF Code	Weight (kg)
16	12	5222.016	350 895 732	0.360
20	15	5222.020	350 895 733	0.390
26	20	5222.026	350 895 734	0.590
32	25	5222.032	350 895 735	0.950
40	32	5222.040	350 895 736	1.360
50	40	5222.050	351 650 970	2.160
63	50	5222.063	351 663 970	3.380

d (mm)	DN (mm)	d1 (mm)	d2 G (inch)	d3 Rp (inch)	d4 (mm)	h (mm)	l1 (mm)	l2 (mm)	z1 (mm)	z2 (mm)	PN (bar)	○
16	12	16	½	¼	53	87	115	133	28	50	10	6
20	15	20	½	¼	53	87	122	137	27	51	10	6
26	20	26	¾	¼	53	105	148	160	27	63	10	6
32	25	32	1	¼	60	117	178	182	28	75	10	6
40	32	40	1 ¼	¼	70	130	212	212	37	92	10	6
50	40	50	1 ½	¼	90	175	256	245	46	108	10	6
63	50	63	2	¼	90	196	315	287	55	134	10	6

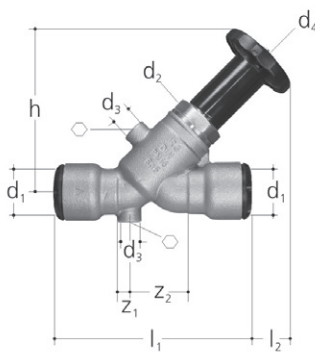

JRG LegioStop Y-type valve sudoFIT gunmetal

- Description: free of water pockets and maintenance free top, non rising handwheel with optical position indicator, valve seat and valve stem made of stainless steel
- Temperature: max. 90°C
- Material: gunmetal, stainless steel, EPDM, plastic
- Connection: push-in system sudoFIT

Approved for the following pipe types and systems: (For other approvals, please contact our technical customer service).

Stainless steel pipes / PN16 / Ø 15, 18, 22, 28, 35, 42, 54 / Mapress / Optipress, Sanpress / inox-PRES

Copper pipes / PN10 / Ø 15, 18, 22, 28, 35, 42, 54 / WICU, KME / SANCO, Wieland-Werke / SANCO, KME

d (mm)	DN (mm)	JRG Code	GF Code	Weight (kg)
15	12	5225.015	351 060 406	0.354
18	15	5225.018	351 060 416	0.401
22	20	5225.022	351 060 426	0.550
28	25	5225.028	351 060 436	0.930
35	32	5225.035	351 060 446	1.370
42	40	5225.042	351 060 676	2.018
54	50	5225.054	351 060 686	2.990

d (mm)	DN (mm)	d1 (mm)	d2 G (inch)	d3 Rp (inch)	d4 (mm)	h (mm)	l1 (mm)	l2 (mm)	z1 (mm)	z2 (mm)	○	PN (bar)
15	12	15	½	¼	53	87	82	37	8	26	6	10/16
18	15	18	½	¼	53	87	98	27	8	31	6	10/16
22	20	22	¾	¼	53	105	103	39	7	35	6	10/16
28	25	28	1	¼	60	117	136	31	9	44	6	10/16
35	32	35	1 ¼	¼	70	130	164	26	11	57	6	10/16
42	40	42	1 ½	¼	90	148	191	27	11	62	6	10/16

Product range Y-type valves

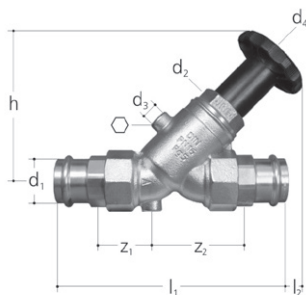

JRG LegioStop Y-type valve Optipress / Sanpress gunmetal

- Description: free of water pockets and maintenance free top, non rising handwheel with optical position indicator, valve seat and valve stem made of stainless steel
- Temperature: max. 90°C
- Material: gunmetal, stainless steel, EPDM, plastic
- Connection: Optipress / Sanpress

d (mm)	DN (mm)	JRG Code	GF Code	Weight (kg)
15	12	5227.015	350 895 677	0.460
18	15	5227.018	350 895 678	0.574
22	20	5227.022	350 895 679	0.680
28	25	5227.028	350 895 680	1.150
35	32	5227.035	350 895 681	1.889
42	40	5227.042	350 895 682	2.130
54	50	5227.054	350 895 683	3.560

d (mm)	DN (mm)	d1 (mm)	d2 G (inch)	d3 Rp (inch)	d4 (mm)	h (mm)	l1 (mm)	l2 (mm)	z1 (mm)	z2 (mm)	PN (bar)	○
15	12	15	½	¼	53	87	131	13	33	50	16	6
18	15	18	½	¼	53	87	131	13	33	50	16	6
22	20	22	¾	¼	53	105	146	21	39	60	16	6
28	25	28	1	¼	60	117	166	21	47	72	16	6
35	32	35	1 ¼	¼	70	130	196	16	56	89	16	6
42	40	42	1 ½	¼	90	148	226	14	57	98	16	6
54	50	54	2	¼	90	169	264	10	59	113	16	6

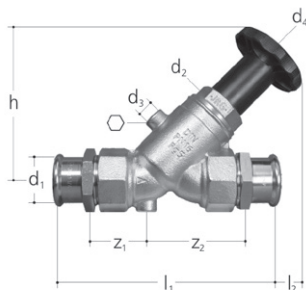

JRG LegioStop Y-type valve Mapress gunmetal

- Description: free of water pockets and maintenance free top, non rising handwheel with optical position indicator, valve seat and valve stem made of stainless steel
- Temperature: max. 90°C
- Material: gunmetal, stainless steel, EPDM, plastic
- Connection: Mapress

d (mm)	DN (mm)	JRG Code	GF Code	Weight (kg)
15	12	5228.015	350 895 684	0.480
18	15	5228.018	350 895 685	0.480
22	20	5228.022	350 895 686	0.670
28	25	5228.028	350 895 687	1.130
35	32	5228.035	350 895 688	1.600
42	40	5228.042	350 895 689	2.090
54	50	5228.054	350 895 690	3.250

d (mm)	DN (mm)	d1 (mm)	d2 G (inch)	d3 Rp (inch)	d4 (mm)	h (mm)	l1 (mm)	l2 (mm)	z1 (mm)	z2 (mm)	PN (bar)	○
15	12	15	½	¼	53	87	123	17	33	50	16	6
18	15	18	½	¼	53	87	125	16	33	51	16	6
22	20	22	¾	¼	53	105	133	27	35	56	16	6
28	25	28	1	¼	60	116	152	28	40	66	16	6
35	32	35	1 ¼	¼	70	130	178	25	47	80	16	6
42	40	42	1 ½	¼	90	148	196	29	48	89	16	6
54	50	54	2	¼	90	169	282	21	79	133	16	6

Product range Y-type valves

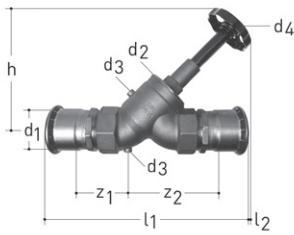

JRG LegioStop Y-type valve Mapress gunmetal

- Description: free of water pockets and maintenance free top, rising handwheel, valve seat and valve stem made of stainless steel
- Temperature: max. 90°C
- Material: gunmetal, stainless steel, EPDM, metal
- Connection: Mapress

DN (mm)	JRG Code	GF Code	Weight (kg)
65	5228.076	350 818 724	5.775
80	5228.088	350 818 819	8.170

d1 (mm)	d2 G (inch)	d3 Rp (inch)	d4 (mm)	h (mm)	l1 (mm)	l2 (mm)	z1 (mm)	z2 (mm)	PN (bar)	⊙
76.1	2 ½	¼	120	260	365	39	92	168	16	6
88.9	3	¼	120	277	425	20	108	198	16	6

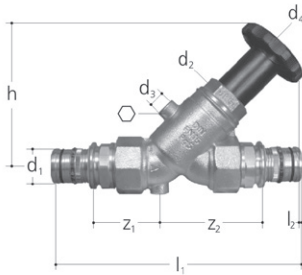

JRG LegioStop Y-type valve Mepla gunmetal

- Description: free of water pockets and maintenance free top, non rising handwheel with optical position indicator, valve seat and valve stem made of stainless steel
- Temperature: max. 90°C
- Material: gunmetal, stainless steel, EPDM, plastic
- Connection: Mepla

d (mm)	DN (mm)	JRG Code	GF Code	Weight (kg)
16	12	5229.016	350 895 691	0.494
20	15	5229.020	350 895 692	0.504
26	20	5229.026	350 895 693	0.764
32	25	5229.032	350 895 694	1.240
40	32	5229.040	350 895 695	1.810
50	40	5229.050	350 895 696	2.560
63	50	5229.063	350 895 697	5.010

d (mm)	DN (mm)	d1 (mm)	d2 G (inch)	d3 Rp (inch)	d4 (mm)	h (mm)	l1 (mm)	l2 (mm)	z1 (mm)	z2 (mm)	PN (bar)	⊙
16	12	16	½	¼	53	87	145	6	39	56	16	6
20	15	20	½	¼	53	87	151	3	40	57	16	6
26	20	26	¾	¼	53	105	173	7	44	65	16	6
32	25	32	1	¼	60	117	182	13	51	76	16	6
40	32	40	1 ¼	¼	70	130	218	5	59	92	16	6
50	40	50	1 ½	¼	90	148	240	7	62	103	16	6
63	50	63	2	¼	90	169	334	25	73	127	16	6

Product range Y-type valves

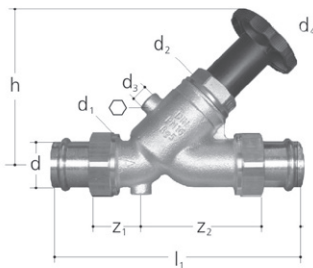

JRG LegioStop Y-type valve with screw connections Optipress / Sanpress gunmetal

- Description: free of water pockets and maintenance free top, non rising handwheel with optical position indicator, valve seat and valve stem made of stainless steel
- Temperature: max. 90°C
- Material: gunmetal, stainless steel, EPDM, plastic
- Connection: Optipress / Sanpress

d (mm)	DN (mm)	JRG Code	GF Code	Weight (kg)
15	12	5234.015	350 895 670	0.500
18	15	5234.018	350 895 671	0.490
22	20	5234.022	350 895 672	0.740

28	25	5234.028	350 895 673	1.180
35	32	5234.035	350 895 674	1.550
42	40	5234.042	350 895 675	2.250
54	50	5234.054	350 895 676	3.420

d (mm)	DN (mm)	d1 G (inch)	d2 G (inch)	d3 Rp (inch)	d4 (mm)	h (mm)	l1 (mm)	z1 (mm)	z2 (mm)	PN (bar)	○
15	12	3/4	1/2	1/4	50	89	143	31	65	16	6
18	15	3/4	1/2	1/4	50	89	148	34	68	16	6
22	20	1	3/4	1/4	60	106	165	39	80	16	6
28	25	1 1/4	1	1/4	70	127	182	42	93	16	6
35	32	1 1/2	1 1/4	1/4	80	149	205	47	107	16	6
42	40	1 3/4	1 1/2	1/4	90	170	246	48	118	16	6
54	50	2 3/8	2	1/4	100	200	271	48	133	16	6

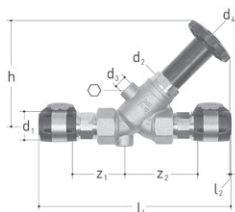

JRG LegioStop Y-type valve FlowFit gunmetal

- Description: free of water pockets and maintenance free top, non rising handwheel with optical position indicator, valve seat and valve stem made of stainless steel
- Temperature: max. 90°C
- Material: gunmetal, stainless steel, EPDM, plastic
- Connection: FlowFit

d (mm)	DN (mm)	JRG Code	GF Code	Weight (kg)
16	12	5239.016	350 895 782	0.512
20	15	5239.020	350 895 783	0.530
25	20	5239.025	350 895 784	0.788
32	25	5239.032	350 895 785	1.280
40	32	5239.040	350 895 786	1.880
50	40	5239.050	350 895 787	2.910
63	50	5239.063	350 895 788	4.632

d (mm)	DN (mm)	d1 (mm)	d2 G (inch)	d3 Rp (inch)	d4 (mm)	h (mm)	l1 (mm)	l2 (mm)	z1 (mm)	z2 (mm)	○
16	12	16	1/2	1/4	53	87	165	4	41	58	6
20	15	20	1/2	1/4	53	87	170	7	43	61	6
25	20	25	3/4	1/4	53	105	185	-1	49	70	6
32	25	32	1	1/4	60	117	210	1	55	80	6
40	32	40	1 1/4	1/4	70	130	225	-2	59	92	6
50	40	50	1 1/2	1/4	90	148	284	15	60	102	6
63	50	63	2	1/4	90	169	330	23	73	127	6

Product range Y-type valves

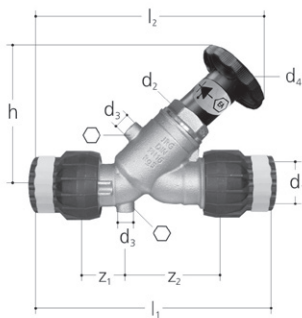

JRG Sanipex MT LegioStop Non-return valve closable gunmetal

- Description: free of water pockets and maintenance free top, non rising handwheel with optical position indicator, valve seat and valve stem made of stainless steel
- Temperature: max. 90°C
- Material: gunmetal, stainless steel, EPDM, plastic
- Connection: JRG Sanipex MT

d (mm)	DN (mm)	JRG Code	GF Code	Weight (kg)
16	12	5262.016	350 896 263	0.352
20	15	5262.020	350 896 264	0.380
26	20	5262.026	350 896 265	0.580
32	25	5262.032	350 896 266	0.950
40	32	5262.040	350 896 267	1.365
50	40	5262.050	350 896 292	2.187
63	50	5262.063	350 896 293	3.465

d (mm)	DN (mm)	d1 (mm)	d2 G (inch)	d3 Rp (inch)	d4 (mm)	h (mm)	l1 (mm)	l2 (mm)	z1 (mm)	z2 (mm)	PN (bar)	⊙
16	12	16	½	¼	53	87	115	133	28	50	10	6
20	15	20	½	¼	53	87	122	137	27	51	10	6
26	20	26	¾	¼	53	105	148	160	27	63	10	6
32	25	32	1	¼	60	117	178	182	28	75	10	6
40	32	40	1 ¼	¼	70	130	218	212	37	92	10	6
50	40	50	1 ½	¼	90	148	256	246	46	108	10	6
63	50	63	2	¼	90	170	315	288	55	134	10	6

Product range Y-type valves

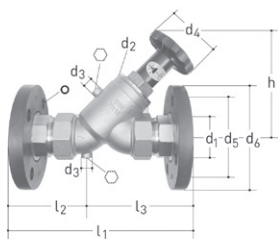

JRG LegioStop Non-return valve closable gunmetal With flanges until DN 50

- Description: free of water pockets and maintenance free top, non rising handwheel with optical position indicator, valve seat and valve stem made of stainless steel
- Temperature: max. 90°C
- Material: gunmetal, stainless steel, EPDM, plastic
- Connection: flange

DN (mm)	d (mm)	JRG Code	GF Code	Weight (kg)
25	25	5264.025	350 818 718	2.530
32	32	5264.032	350 818 719	3.500
40	40	5264.040	350 818 720	4.540
50	50	5264.050	350 818 721	7.080

DN (mm)	d1 (mm)	d2 G (inch)	d3 Rp (inch)	d4 (mm)	d5 (mm)	d6 (mm)	h (mm)	l1 (mm)	l2 (mm)	l3 (mm)	PN (bar)	○	◇
25	25	1	¼	60	85	115	117	188	82	107	16	4x14	6
32	32	1 ¼	¼	70	100	140	130	213	90	123	16	4x18	6
40	40	1 ½	¼	90	110	150	148	229	94	135	16	4x18	6
50	50	2	¼	90	125	165	169	262	104	158	16	4x18	6

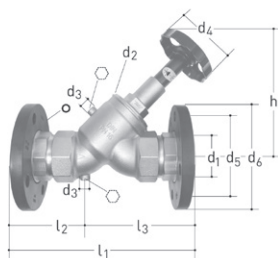

JRG LegioStop Non-return valve closable gunmetal With flanges

- Description: free of water pockets and maintenance free top, rising handwheel, valve seat and valve stem made of stainless steel
- Temperature: max. 90°C
- Material: gunmetal, stainless steel, EPDM, metal
- Connection: flange

DN (mm)	d (mm)	JRG Code	GF Code	Weight (kg)
65	65	5264.065	350 818 722	10.340

d1 (mm)	d2 G (inch)	d3 Rp (inch)	d4 (mm)	d5 (mm)	d6 (mm)	h (mm)	l1 (mm)	l2 (mm)	l3 (mm)	PN (bar)	○	◇
65	2 ½	¼	120	145	185	260	296	110	186	16	4x18	6

Product range Y-type valves

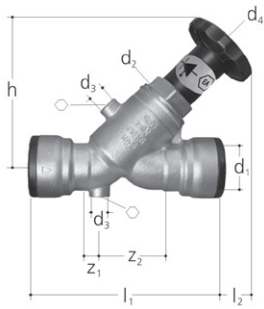

JRG LegioStop Non-return valve sudoFIT closable gunmetal

- Description: free of water pockets and maintenance free top, non rising handwheel with optical position indicator, valve seat and valve stem made of stainless steel
- Temperature: max. 90°C
- Material: gunmetal, stainless steel, EPDM, plastic
- Connection: push-in system sudoFIT
- ***PN16**: stainless steel pipes, **PN10**: copper pipes

For assembly/disassembly procedures, please refer to the assembly instructions included with the JRG Code 8130.000 assembly case and available at www.gfps.com.

d (mm)	DN (mm)	JRG Code	GF Code	Weight (kg)
15	12	5265.015	351 060 403	0.350
18	15	5265.018	351 060 413	0.390
22	20	5265.022	351 060 423	0.540
28	25	5265.028	351 060 433	0.930
35	32	5265.035	351 060 443	1.330
42	40	5265.042	351 060 673	1.830
54	50	5265.054	351 060 683	2.840

d (mm)	DN (mm)	d1 (mm)	d2 G (inch)	d3 Rp (inch)	d4 (mm)	h (mm)	l1 (mm)	l2 (mm)	PN (bar)	z1 (mm)	z2 (mm)	⊙
15	12	15	½	¼	53	87	82	37	10/16	8	26	6
18	15	18	½	¼	53	87	98	27	10/16	8	31	6
22	20	22	¾	¼	53	105	103	39	10/16	7	35	6
28	25	28	1	¼	60	117	136	31	10/16	9	44	6
35	32	35	1 ¼	¼	70	130	164	26	10/16	11	57	6
42	40	42	1 ½	¼	90	148	191	27	10/16	11	62	6
54	50	54	2	¼	90	169	231	21	10/16	14	79	6

Product range Y-type valves

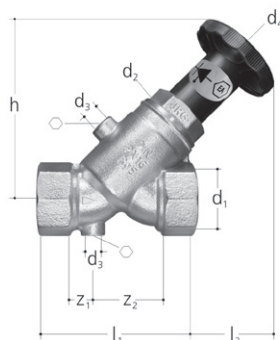

JRG LegioStop Non-return valve closable gunmetal Until DN 50

- Description: free of water pockets and maintenance free top, non rising handwheel with optical position indicator, valve seat and valve stem made of stainless steel
- Temperature: max. 90°C
- Material: gunmetal, stainless steel, EPDM, plastic
- Connection: female thread

GN (inch)	Size (inch)	DN (mm)	JRG Code	GF Code	Weight (kg)
1/2	1/2	15	5266.240	350 896 200	0.367
3/4	3/4	20	5266.320	350 896 201	0.510
1	1	25	5266.400	350 896 202	0.880
1 1/4	1 1/4	32	5266.480	350 896 203	1.253
1 1/2	1 1/2	40	5266.560	350 896 204	1.662
2	2	50	5266.640	350 896 205	2.523

d1 Rp (inch)	d2 G (inch)	d3 Rp (inch)	d4 (mm)	h (mm)	l1 (mm)	l2 (mm)	z1 (mm)	z2 (mm)	PN (bar)	⊕
1/2	1/2	1/4	53	87	65	46	10	27	16	6
3/4	3/4	1/4	53	105	75	56	12	33	16	6
1	1	1/4	60	117	90	59	15	40	16	6
1 1/4	1 1/4	1/4	70	130	110	59	19	52	16	6
1 1/2	1 1/2	1/4	90	148	120	67	20	61	16	6
2	2	1/4	90	169	150	67	23	77	16	6

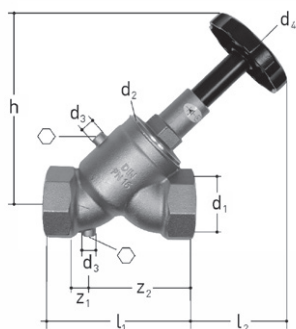

JRG LegioStop Non-return valve closable gunmetal Unit DN 65

- Description: free of water pockets and maintenance free top, rising handwheel, valve seat and valve stem made of stainless steel
- Temperature: max. 90°C
- Material: gunmetal, stainless steel, EPDM, metal
- Connection: female thread

GN (inch)	Size (inch)	DN (mm)	JRG Code	GF Code	Weight (kg)
2 1/2	2 1/2	65	5266.720	350 818 704	4.210

d1 Rp (inch)	d2 G (inch)	d3 Rp (inch)	d4 (mm)	h (mm)	l1 (mm)	l2 (mm)	z1 (mm)	z2 (mm)	PN (bar)	⊕
2 1/2	2 1/2	1/4	120	260	180	132	22	98	16	6

Product range Y-type valves

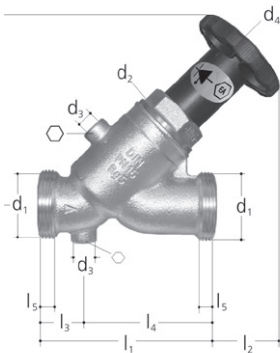

JRG LegioStop Non-return valve closable gunmetal Until DN 50

- Description: free of water pockets and maintenance free top, non rising handwheel with optical position indicator, valve seat and valve stem made of stainless steel
- Temperature: max. 90°C
- Material: gunmetal, stainless steel, EPDM, plastic
- Connection: male thread

DN (mm)	Size (inch)	JRG Code	GF Code	Weight (kg)
15	½	5281.015	350 896 206	0.352
20	¾	5281.020	350 896 207	0.520
25	1	5281.025	350 896 208	0.858
32	1 ¼	5281.032	350 896 209	1.130
40	1 ½	5281.040	350 896 210	1.490
50	2	5281.050	350 896 211	2.200

DN (mm)	d1 G (inch)	d2 G (inch)	d3 Rp (inch)	d4 (mm)	h (mm)	l1 (mm)	l2 (mm)	l3 (mm)	l4 (mm)	l5 (mm)	PN (bar)	⊙
15	¾	½	¼	53	87	75	35	24	52	6	16	6
20	1	¾	¼	53	105	87	42	24	63	7	16	6
25	1 ¼	1	¼	60	117	99	42	25	75	8	16	6
32	1 ½	1 ¼	¼	70	130	118	42	30	89	9	16	6
40	1 ¾	1 ½	¼	90	148	130	48	31	100	10	16	6
50	2 ¾	2	¼	90	169	155	49	35	120	11	16	6

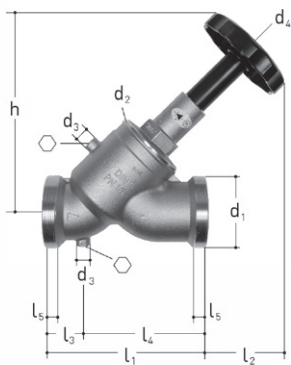

JRG LegioStop Non-return valve closable gunmetal DN 65

- Description: free of water pockets and maintenance free top, rising handwheel, valve seat and valve stem made of stainless steel
- Temperature: max. 90°C
- Material: gunmetal, stainless steel, EPDM, metal
- Connection: male thread

DN (mm)	Size (inch)	JRG Code	GF Code	Weight (kg)
65	2 ½	5281.065	351 057 003	4.030

DN (mm)	d1 G (inch)	d2 G (inch)	d3 Rp (inch)	d4 (mm)	h (mm)	l1 (mm)	l2 (mm)	l3 (mm)	l4 (mm)	l5 (mm)	PN (bar)	⊙
65	3	2 ½	¼	120	260	190	113	43	147	15	16	6

Product range Y-type valves

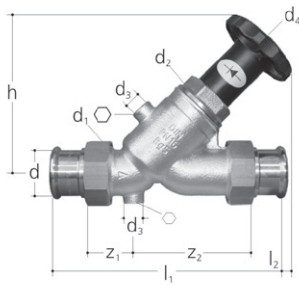

JRG LegioStop Non-return valve closable gunmetal With screw connections Mapress

- Description: free of water pockets and maintenance free top, non rising handwheel with optical position indicator, valve seat and valve stem made of stainless steel
- Temperature: max. 90°C
- Material: gunmetal, stainless steel, EPDM, plastic
- Connection: male thread Mapress

d (mm)	DN (mm)	JRG Code	GF Code	Weight (kg)
15	12	5283.015	350 896 218	0.510
18	15	5283.018	350 896 219	0.490
22	20	5283.022	350 896 220	0.730
28	25	5283.028	350 896 221	1.150
35	32	5283.035	350 896 222	1.574
42	40	5283.042	350 896 223	1.970
54	50	5283.054	350 896 224	3.195

d (mm)	DN (mm)	d1 G (inch)	d2 G (inch)	d3 Rp (inch)	d4 (mm)	h (mm)	l1 (mm)	l2 (mm)	z1 (mm)	z2 (mm)	PN (bar)	⊙
15	12	3/8	1/2	1/4	53	87	131	18	35	63	16	6
18	15	3/8	1/2	1/4	53	87	131	18	35	63	16	6
22	20	1	3/4	1/4	53	105	149	22	35	74	16	6
28	25	1 1/4	1	1/4	60	117	165	22	38	88	16	6
35	32	1 1/2	1 1/4	1/4	70	130	184	22	43	102	16	6
42	40	1 3/4	1 1/2	1/4	90	148	208	22	44	113	16	6
54	50	2 3/8	2	1/4	90	169	239	22	50	135	16	6

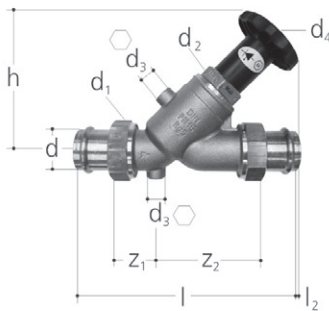

JRG LegioStop Non-return valve closable gunmetal With screw connections Optipress / Sanpress

- Description: free of water pockets and maintenance free top, non rising handwheel with optical position indicator, valve seat and valve stem made of stainless steel
- Temperature: max. 90°C
- Material: gunmetal, stainless steel, EPDM, plastic
- Connection: male thread Optipress / Sanpress

d (mm)	DN (mm)	JRG Code	GF Code	Weight (kg)
15	12	5284.015	350 896 285	0.490
18	15	5284.018	350 896 286	0.492
22	20	5284.022	350 896 287	0.730
28	25	5284.028	350 896 288	1.155
35	32	5284.035	350 896 289	1.510
42	40	5284.042	350 896 290	2.190
54	50	5284.054	350 896 291	3.290

d (mm)	DN (mm)	d1 G (inch)	d2 G (inch)	d3 Rp (inch)	d4 (mm)	h (mm)	l1 (mm)	l2 (mm)	z1 (mm)	z2 (mm)	PN (bar)	⊙
15	12	3/8	1/2	1/4	53	87	149	16	37	65	16	6
18	15	3/8	1/2	1/4	53	87	155	13	40	68	16	6
22	20	1	3/4	1/4	53	105	165	18	39	78	16	6
28	25	1 1/4	1	1/4	60	117	183	17	42	93	16	6
35	32	1 1/2	1 1/4	1/4	70	130	206	17	48	107	16	6
42	40	1 3/4	1 1/2	1/4	90	148	252	15	51	120	16	6
54	50	2 3/8	2	1/4	90	169	277	22	50	135	16	6

Product range straight seat valves

JRG LegioStop Straight seat valve gunmetal

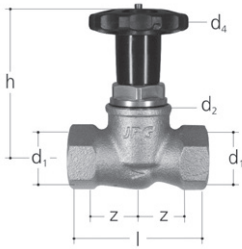

- Description: free of water pockets and maintenance free top, non rising handwheel with optical position indicator, valve seat and valve stem made of stainless steel
- Temperature: max. 90°C
- Material: gunmetal, stainless steel, EPDM, plastic
- Connection: female thread

DN (mm)	Size (inch)	GN (inch)	JRG Code	GF Code	Weight (kg)	d1 Rp (inch)	d2 G (inch)	d4 (mm)	h (mm)	l (mm)	PN (bar)	z (mm)
15	½	½	5350.240	350 895 800	0.280	½	½	53	70	60	16	17
20	¾	¾	5350.320	350 895 801	0.490	¾	¾	53	79	75	16	23
25	1	1	5350.400	350 895 802	0.800	1	1	60	89	90	16	28
32	1 ¼	1 ¼	5350.480	350 895 803	1.180	1 ¼	1 ¼	70	98	105	16	34
40	1 ½	1 ½	5350.560	350 895 804	1.710	1 ½	1 ½	90	110	120	16	41
50	2	2	5350.640	350 895 805	2.450	2	2	90	123	140	16	46

JRG LegioStop Straight seat valve gunmetal

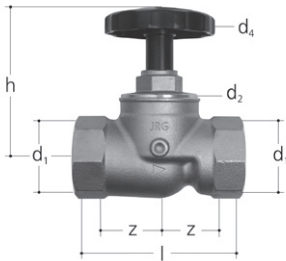

- Description: free of water pockets and maintenance free top, rising handwheel, valve seat and valve stem made of stainless steel
- Temperature: max. 90°C
- Material: gunmetal, stainless steel, EPDM, plastic
- Connection: female thread

Size (inch)	GN (inch)	DN (mm)	JRG Code	GF Code	Weight (kg)	d1 Rp (inch)	d2 G (inch)	d4 (mm)	h (mm)	l (mm)	z (mm)	PN (bar)
2 ½	2 ½	65	5350.720	350 895 828	3.915	2 ½	2 ½	120	162	180	60	16

JRG LegioStop Straight seat valve with flanges gunmetal

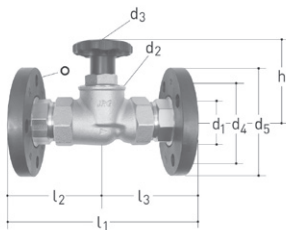

- Description: free of water pockets and maintenance free top, non rising handwheel with optical position indicator, valve seat and valve stem made of stainless steel
- Temperature: max. 90°C
- Material: gunmetal, stainless steel, EPDM, plastic
- Connection: flange

DN (mm)	d (mm)	JRG Code	GF Code	Weight (kg)
25	25	5351.025	350 895 847	2.360
32	32	5351.032	350 895 848	3.410
40	40	5351.040	350 895 849	4.580
50	50	5351.050	350 895 850	6.880

DN (mm)	d1 (mm)	d2 G (inch)	d3 (mm)	d4 (mm)	d5 (mm)	h (mm)	l1 (mm)	l2 (mm)	l3 (mm)	PN (bar)	○
25	25	1	60	85	115	89	188	94	94	16	4x14
32	32	1 ¼	70	100	140	98	208	104	104	16	4x18
40	40	1 ½	90	110	150	110	229	115	115	16	4x18
50	50	2	90	125	165	123	252	126	126	16	4x18

Product range straight seat valves

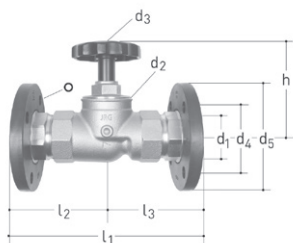

JRG LegioStop Straight seat valve with flanges gunmetal

- Description: free of water pockets and maintenance free top, rising handwheel, valve seat and valve stem made of stainless steel
- Temperature: max. 90°C
- Material: gunmetal, stainless steel, EPDM, plastic
- Connection: flange

DN (mm)	d (mm)	JRG Code	GF Code	Weight (kg)
65	65	5351.065	350 895 851	10.070

DN (mm)	d1 (mm)	d2 G (inch)	d3 (mm)	d4 (mm)	d5 (mm)	h (mm)	l1 (mm)	l2 (mm)	l3 (mm)	PN (bar)	○
65	65	2 ½	120	145	185	161.5	296	148	148	16	4x18

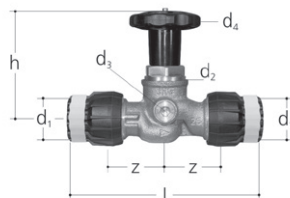

JRG Sanipex MT LegioStop Straight seat valve gunmetal

- Description: free of water pockets and maintenance free top, non rising handwheel with optical position indicator, valve seat and valve stem made of stainless steel
- Temperature: max. 90°C
- Material: gunmetal, stainless steel, EPDM, plastic
- Connection: JRG Sanipex MT

DN (mm)	d (mm)	JRG Code	GF Code	Weight (kg)	d1 (mm)	d2 G (inch)	d3 Rp (inch)	d4 (mm)	h (mm)	l (mm)	z (mm)	PN (bar)
12	16	5354.016	351 616 985	0.300	16	½	¼	53	70	108	37	10
15	20	5354.020	351 620 985	0.350	20	½	¼	53	70	120	39	10
20	26	5354.026	351 626 985	0.554	26	¾	¼	53	78	137	41	10
25	32	5354.032	351 632 985	0.860	32	1	¼	60	89	172	49	10

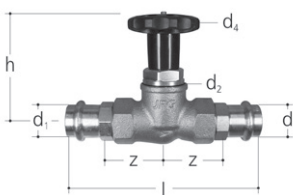

JRG LegioStop Straight seat valve Optipress / Sanpress gunmetal

- Description: free of water pockets and maintenance free top, non rising handwheel with optical position indicator, valve seat and valve stem made of stainless steel
- Temperature: max. 90°C
- Material: gunmetal, stainless steel, EPDM, plastic
- Connection: Optipress / Sanpress

DN (mm)	d (mm)	JRG Code	GF Code	Weight (kg)	d1 (mm)	d2 G (inch)	d4 (mm)	h (mm)	l (mm)	z (mm)	PN (bar)
12	15	5357.015	350 895 812	0.380	15	½	53	70	123	38	16
15	18	5357.018	350 895 813	0.390	18	½	53	70	122	37	16
20	22	5357.022	350 895 814	0.630	22	¾	53	79	147	50	16
25	28	5357.028	350 895 815	1.030	28	1	60	89	167	60	16

Product range straight seat valves

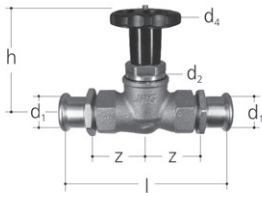

JRG LegioStop Straight seat valve Mapress gunmetal Until DN 50

- Description: free of water pockets and maintenance free top, non rising handwheel with optical position indicator, valve seat and valve stem made of stainless steel
- Temperature: max. 90°C
- Material: gunmetal, stainless steel, EPDM, plastic
- Connection: Mapress

DN (mm)	d (mm)	JRG Code	GF Code	Weight (kg)	d1 (mm)	d2 G (inch)	d4 (mm)	h (mm)	l (mm)	z (mm)	PN (bar)
12	15	5358.015	350 895 816	0.350	15	1/2	53	70	116	38	16
15	18	5358.018	350 895 817	0.410	18	1/2	53	70	122	41	16
20	22	5358.022	350 895 818	0.620	22	3/4	53	79	136	47	16
25	28	5358.028	350 895 819	1.010	28	1	60	89	155	55	16
32	35	5358.035	350 895 859	1.550	35	1 1/4	70	98	173	61	16
40	42	5358.042	350 895 860	2.100	42	1 1/2	90	110	196	68	16
50	54	5358.054	350 895 861	3.010	54	2	90	123	271	101	16

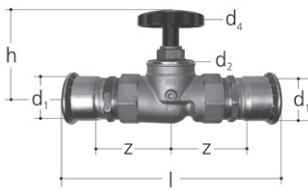

JRG LegioStop Straight seat valve Mapress gunmetal DN 65

- Description: free of water pockets and maintenance free top, rising handwheel, valve seat and valve stem made of stainless steel
- Temperature: max. 90°C
- Material: gunmetal, stainless steel, EPDM, metal
- Connection: Mapress

DN (mm)	d (mm)	JRG Code	GF Code	Weight (kg)	d1 (mm)	d2 G (inch)	d4 (mm)	h (mm)	l (mm)	z (mm)	PN (bar)
65	76.1	5358.076	350 895 862	5.485	76.1	2 1/2	120	162	365	130	16

Product range straight seat valves

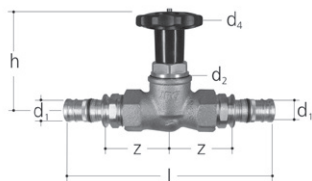

JRG LegioStop Straight seat valve Mepla gunmetal

- Description: free of water pockets and maintenance free top, non rising handwheel with optical position indicator, valve seat and valve stem made of stainless steel
- Temperature: max. 90°C
- Material: gunmetal, stainless steel, EPDM, plastic
- Connection: Mepla

DN (mm)	d (mm)	JRG Code	GF Code	Weight (kg)	d1 (mm)	d2 G (inch)	d4 (mm)	h (mm)	l (mm)	z (mm)	PN (bar)
12	16	5359.016	350 895 820	0.390	16	½	53	70	144	47	10
15	20	5359.020	350 895 821	0.425	20	½	53	70	150	48	10
20	26	5359.026	350 895 822	0.665	26	¾	53	79	174	55	10
25	32	5359.032	350 895 823	1.129	32	1	60	89	185	64	10

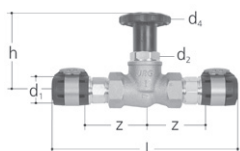

JRG LegioStop Straight seat valve FlowFit gunmetal

- Description: free of water pockets and maintenance free top, non rising handwheel with optical position indicator, valve seat and valve stem made of stainless steel
- Temperature: max. 90°C
- Material: gunmetal, stainless steel, EPDM, plastic
- Connection: FlowFit

d (mm)	DN (mm)	JRG Code	GF Code	Weight (kg)	d1 (mm)	d2 G (inch)	d4 (mm)	h (mm)	l (mm)	z (mm)
16	12	5364.016	350 895 790	0.422	16	½	53	70	160	47
20	15	5364.020	350 895 791	0.650	20	½	53	70	165	50
25	20	5364.025	350 895 792	1.034	25	¾	53	79	185	60
32	25	5364.032	350 895 793	1.570	32	1	60	89	210	68

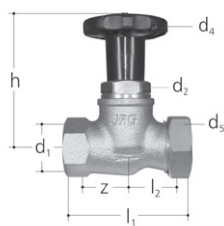

JRG LegioStop Straight seat valve with cap gunmetal

- Description: free of water pockets and maintenance free top, non rising handwheel with optical position indicator, valve seat and valve stem made of stainless steel
- Temperature: max. 90°C
- Material: gunmetal, stainless steel, EPDM, plastic
- Connection: inlet female thread, outlet with cap

DN (mm)	GN (inch)	Size (inch)	JRG Code	GF Code	Weight (kg)
15	½	½	5363.240	350 895 826	0.300
20	¾	¾	5363.320	350 895 827	0.495

DN (mm)	d1 (inch)	Rp (inch)	d2 G (inch)	d4 (mm)	d5 G (inch)	h (mm)	l1 (mm)	l2 (mm)	z (mm)	PN (bar)
15	½	½	53	53	¾	70	63	29	17	16
20	¾	¾	53	53	1	79	76	34	23	16

Product range straight seat valves

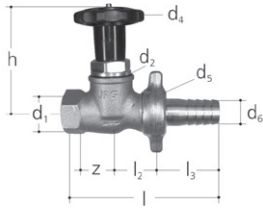

JRG LegioStop Straight seat valve gunmetal With outlet hose screw connection

- Description: free of water pockets and maintenance free top, non rising handwheel with optical position indicator, valve seat and valve stem made of stainless steel
- Temperature: max. 90°C
- Material: gunmetal, stainless steel, EPDM, plastic
- Connection: inlet female thread, outlet hose screw connection

DN (mm)	Size (inch)	GN (inch)	JRG Code	GF Code	Weight (kg)
15	½	½	5360.240	350 895 824	0.360
20	¾	¾	5360.320	350 895 825	0.550

DN (mm)	d1 (inch)	Rp (inch)	d2 G (inch)	d4 (mm)	d5 G (inch)	d6 (mm)	h (mm)	l (mm)	l2 (mm)	l3 (mm)	z (mm)	PN (bar)
15	½	½	½	53	¾	16	70	104	29	45	17	16
20	¾	¾	¾	53	1	19	79	120	34	49	23	16

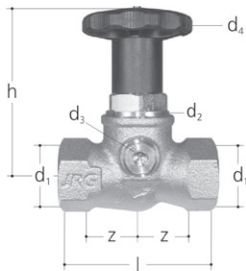

JRG LegioStop Straight seat valve gunmetal

- Description: free of water pockets and maintenance free top, non rising handwheel with optical position indicator, valve seat and valve stem made of stainless steel
- Temperature: max. 90°C
- Material: gunmetal, stainless steel, EPDM, plastic
- Connection: female thread

DN (mm)	GN (inch)	Size (inch)	JRG Code	GF Code	Weight (kg)
15	½	½	5371.240	350 895 806	0.310
20	¾	¾	5371.320	350 895 807	0.470
25	1	1	5371.400	350 895 808	0.810
32	1 ¼	1 ¼	5371.480	350 895 809	1.150
40	1 ½	1 ½	5371.560	350 895 810	1.725
50	2	2	5371.640	350 895 811	2.380

DN (mm)	d1 (inch)	Rp (inch)	d2 G (inch)	d3 Rp (inch)	d4 (mm)	h (mm)	l (mm)	z (mm)	PN (bar)
15	½	½	½	¼	53	70	60	17	16
20	¾	¾	¾	¼	53	79	75	23	16
25	1	1	1	¼	60	89	90	28	16
32	1 ¼	1 ¼	1 ¼	¾	70	98	105	34	16
40	1 ½	1 ½	1 ½	¾	90	110	120	41	16
50	2	2	2	¾	90	123	140	46	16

Product range straight seat valves

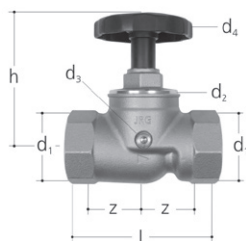

JRG LegioStop Straight seat valve gunmetal

- Description: free of water pockets and maintenance free top, rising handwheel, valve seat and valve stem made of stainless steel
- Temperature: max. 90°C
- Material: gunmetal, stainless steel, EPDM, metal
- Connection: female thread

DN (mm)	GN (inch)	Size (inch)	JRG Code	GF Code	Weight (kg)
65	2 ½	2 ½	5371.720	350 895 830	3.910

DN (mm)	d1 (inch)	Rp (inch)	d2 G (inch)	d3 Rp (inch)	d4 (mm)	h (mm)	l (mm)	z (mm)	PN (bar)
65	2 ½	2 ½	¼	¼	120	162	180	60	16

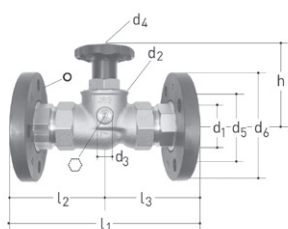

JRG LegioStop Straight seat valve with flanges gunmetal

- Description: free of water pockets and maintenance free top, non rising handwheel with optical position indicator, valve seat and valve stem made of stainless steel
- Temperature: max. 90°C
- Material: gunmetal, stainless steel, EPDM, plastic
- Connection: flange

DN (mm)	d (mm)	JRG Code	GF Code	Weight (kg)
25	25	5374.025	350 895 852	2.380
32	32	5374.032	350 895 853	3.460
40	40	5374.040	350 895 854	4.600
50	50	5374.050	350 895 855	6.160

DN (mm)	d1 (mm)	d2 G (inch)	d3 Rp (inch)	d4 (mm)	d5 (mm)	d6 (mm)	h (mm)	l1 (mm)	l2 (mm)	l3 (mm)	PN (bar)	○	◇
25	25	1	¼	60	85	115	90	188	94	94	16	4x14	6
32	32	1 ¼	¼	70	100	140	105	208	104	104	16	4x18	6
40	40	1 ½	¼	90	110	150	120	229	115	115	16	4x18	6
50	50	2	¼	90	125	165	140	252	126	126	16	4x18	6

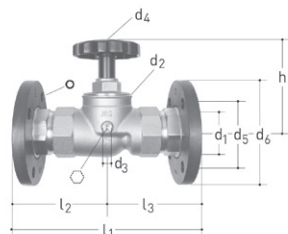

JRG LegioStop Straight seat valve gunmetal With flanges DN 65

- Description: free of water pockets and maintenance free top, rising handwheel, valve seat and valve stem made of stainless steel
- Temperature: max. 90°C
- Material: gunmetal, stainless steel, EPDM, metal
- Connection: flange

DN (mm)	d (mm)	JRG Code	GF Code	Weight (kg)
65	65	5374.065	350 895 856	8.650

DN (mm)	d1 (mm)	d2 G (inch)	d3 Rp (inch)	d4 (mm)	d5 (mm)	d6 (mm)	h (mm)	l1 (mm)	l2 (mm)	l3 (mm)	PN (bar)	○	◇
65	65	2 ½	¼	120	145	185	162	296	148	148	16	4x18	6

Product range accessories

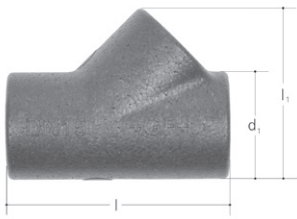

JRG Sanipex MT Insulation box for system valves EPP

- Description: Fits to JRG Sanipex MT valves (5222, 5262), valves with union thread (1611, 5211, 5213, 5234, 5281, 5283, 5284) and sudoFIT valves (1615, 5225, 5265; eventually adjustments with cutter knife needed)
- Material: Expanded polypropylene (EPP)
- Temperature: max. 110°C
- Thermal conductivity: 0.035 W/mK according EN 12667
- Building material class: B2 according DIN 4102 and E according EN 13501-1

d (mm)	JRG Code	Weight (kg)	GF Code	d1 (mm)	l (mm)	l1 (mm)
16 + 20	5222.516	0.020	351 616 670	62	128	68
26	5222.526	0.035	351 626 670	68	156	78
32	5222.532	0.050	351 632 670	95	181	97
40	5222.540	0.065	351 640 670	122	220	118
50	5222.550	0.080	351 650 670	134	257	130
63	5222.563	0.100	351 663 670	164	339	235

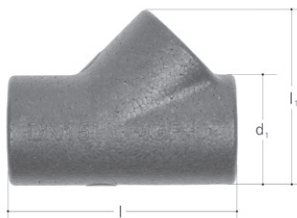

JRG Insulation box for valves EPP

- Description: Fits to valves with female thread (1610, 1812, 5200, 5221, 5266), valves with flange (1614, 1814, 5204, 5264) and valves for press-systems (5207, 5208, 5228, 5229)
- Material: Expanded polypropylene (EPP)
- Temperature: max. 110°C
- Thermal conductivity: 0.035 W/mK according EN 12667
- Building material class: B2 according DIN 4102 and E according EN 13501-1

d (mm)	JRG Code	GF Code	Weight (kg)	d1 (mm)	l (mm)	l1 (mm)
15	5289.240	351 615 674	0.0110	62	99	95
20	5289.320	351 620 674	0.0140	68	112	105
25	5289.400	351 625 674	0.0334	95	132	137
32	5289.480	351 632 674	0.0704	122	162	172
40	5289.560	351 640 674	0.0915	134	174	190
50	5289.640	351 650 674	0.1551	164	194	233
65	5289.720	351 665 674	0.2116	180	238	253
80	5289.800	351 680 674	0.3282	210	276	290

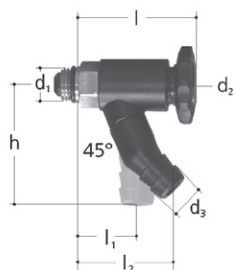

JRG LegioStop drain valve brass

- Temperature: max. 90°C
 - Material: brass
 - Connection: male thread
- * to 5120

DN (mm)	Size (inch)	GN (inch)	JRG Code	GF Code	Weight (kg)
8	¼	¼	7301.080	350 896 020	0.053
10	¾	¾	7301.160	350 896 024	0.053
*	10	¾	7301.302	350 896 025	0.043

DN (mm)	d1 (inch)	R (mm)	d2 (mm)	d3 (mm)	h (mm)	l (mm)	l1 (mm)	l2 (mm)	PN (bar)
8	¼	30	14	45	46	25	38	16	
10	¾	30	14	45	59	38	50	16	
*	10	¾	30	14	45	67	46	58	16

Product range accessories

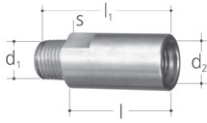

JRG Drain cock extension brass lead-free

- Material: brass lead-free

GN (inch)	DN (mm)	JRG Code	GF Code	Weight (kg)	d1 R (inch)	d2 Rp (inch)	l (mm)	l1 (mm)	s (mm)
1/4	8	7305.080	355 633 002	0.055	1/4	1/4	34	43	16

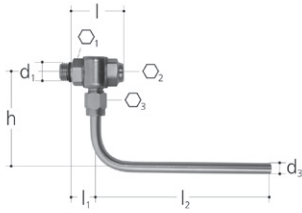

JRG Sampling Valve gunmetal

- Description: for microbiological water analysis
- Temperature: max. 90°C
- Material: gunmetal, stainless steel, EPDM
- Connection: male thread

DN (mm)	Size (inch)	GN (inch)	JRG Code	GF Code	Weight (kg)
8	1/4	1/4	7306.080	351 110 365	0.190
10	3/8	3/8	7306.160	351 110 500	0.190

DN (mm)	d1 R (inch)	d3 (mm)	h (mm)	l (mm)	l1 (mm)	l2 (mm)	PN (bar)	O1	O3	O2
8	1/4	8	65	35	16	125	16	20	14	5
10	3/8	8	65	35	16	125	16	20	14	5

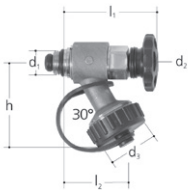

JRG LegioStop drain cock brass lead-free with 3/4" hose connection

- Nominal pressure: PN16
- Temperature: max. 90°C
- Material: brass lead-free
- Connection: male thread

Note: Piping installations must not be filled via these drain cock!

DN (mm)	Thread Type	Size (inch)	JRG Code	Weight (kg)	GF Code	d1 R (inch)	d2 (mm)	d3 G (inch)	h (mm)	l1 (mm)	l2 (mm)
8	R	1/4	7401.080	0.100	350 896 026	1/4	30	3/4	44	50	30
10	R	3/8	7401.160	0.125	350 896 027	3/8	30	3/4	44	63	42

Product range accessories



JRG LegioStop Marking plate green plastic

- Description: to JRG LegioStop upper part
- Material: plastic

d (mm)	GN (inch)	JRG Code	GF Code	Weight (kg)
53	½ - ¾	8501.100	350 894 086	0.001
60	1	8501.101	350 894 286	0.001
70	1 ¼	8501.102	350 894 386	0.002
90	1 ½ - 3	8501.103	350 894 486	0.003



JRG LegioStop Marking plate red plastic

- Description: to JRG LegioStop upper part
- Material: plastic

d (mm)	GN (inch)	JRG Code	GF Code	Weight (kg)
53	½ - ¾	8501.200	350 894 087	0.001
60	1	8501.201	350 894 287	0.001
70	1 ¼	8501.202	350 894 387	0.002
90	1 ½ - 3	8501.203	350 894 487	0.003



JRG LegioStop Marking plate blue plastic

- Description: to JRG LegioStop upper part
- Material: plastic

d (mm)	GN (inch)	JRG Code	GF Code	Weight (kg)
53	½ - ¾	8501.300	350 894 088	0.001
60	1	8501.301	350 894 288	0.001
70	1 ¼	8501.302	350 894 388	0.002
90	1 ½ - 3	8501.303	350 894 488	0.003



JRG LegioStop Marking plate orange plastic

- Description: to JRG LegioStop upper part
- Material: plastic

d (mm)	GN (inch)	JRG Code	GF Code	Weight (kg)
53	½ - ¾	8501.400	350 894 089	0.001
60	1	8501.401	350 894 289	0.001
70	1 ¼	8501.402	350 894 389	0.002
90	1 ½ - 3	8501.403	350 894 489	0.003

Product range spare parts



JRG Check valve gunmetal upper part Until DN50

- Temperature: max. 90°C
- Material: gunmetal, stainless steel, EPDM, plastic

GN (inch)	DN (mm)	JRG Code	GF Code	Weight (kg)	d2 G (inch)	h / DIN 3502 (mm)
½	15	1628.240	350 894 008	0.150	½	35
¾	20	1628.320	350 894 108	0.190	¾	43
1	25	1628.400	350 894 208	0.340	1	52
1 ¼	32	1628.480	350 894 308	0.295	1 ¼	63
1 ½	40	1628.560	350 894 408	0.380	1 ½	72
2	50	1628.640	350 894 508	0.110	2	89



JRG Check valve gunmetal Upper part DN65

- Temperature: max. 90°C
- Material: gunmetal, stainless steel, EPDM, plastic

GN (inch)	DN (mm)	JRG Code	GF Code	Weight (kg)	d2 G (inch)	h / DIN 3502 (mm)
2 ½	65	1628.720	350 894 608	1.050	2 ½	91



JRG LegioStop Non-return valve closable Upper part Until DN 50

- Description: free of water pockets and maintenance free top, non rising handwheel with optical position indicator
- Material: gunmetal, stainless steel, EPDM, plastic
- Temperature: max. 90°C

GN (inch)	DN (mm)	JRG Code	GF Code	Weight (kg)	d2 G (inch)	d4 (mm)	h (mm)	hub / DIN 3502 (mm)
½	15	5295.240	350 894 005	0.203	½	53	37	35
¾	20	5295.320	350 894 105	0.280	¾	53	44	43
1	25	5295.400	350 894 205	0.460	1	60	53	52
1 ¼	32	5295.480	350 894 305	0.533	1 ¼	70	64	63
1 ½	40	5295.560	350 894 405	0.730	1 ½	90	73	72
2	50	5295.640	350 894 505	0.920	2	90	89	89



JRG LegioStop Straight seat valve Upper part DN65

- Description: free of water pockets and maintenance free top, rising handwheel
- Temperature: max. 90°C
- Material: gunmetal, stainless steel, EPDM, metal

GN (inch)	DN (mm)	JRG Code	GF Code	Weight (kg)	d2 G (inch)	d4 (mm)	h (mm)	hub max. (mm)	hub / DIN 3512 (mm)
2 ½	65	5395.720	350 895 400	1.450	2 ½	120	37	24	30

Product range spare parts

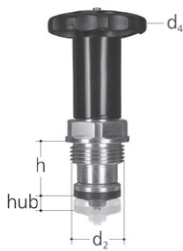

JRG LegioStop Y-type valve Upper part Unit DN 50

- Description: free of water pockets and maintenance free top, non rising handwheel with optical position indicator
- Temperature: max. 90°C
- Material: gunmetal, brass, EPDM, plastic

GN (inch)	DN (mm)	JRG Code	GF Code	Weight (kg)	d2 G (inch)	d4 (mm)	h (mm)	hub max. (mm)	hub / DIN 3502 (mm)
½	15	5290.240	350 894 000	0.150	½	53	23	17	12.0
¾	20	5290.320	350 894 100	0.240	¾	53	26	22	17.0
1	25	5290.400	350 894 200	0.410	1	60	34	24	18.5
1 ¼	32	5290.480	350 894 300	0.510	1 ¼	70	37	32	26.5
1 ½	40	5290.560	350 894 400	0.730	1 ½	90	43	35	29.5
2	50	5290.640	350 894 500	0.970	2	90	52	43	37.5



JRG LegioStop Y-type valve Upper part From DN 65

- Description: free of water pockets and maintenance free top, rising handwheel
- Temperature: max. 90°C
- Material: gunmetal, brass, EPDM, metal

GN (inch)	DN (mm)	JRG Code	GF Code	Weight (kg)	d2 G (inch)	d4 (mm)	h (mm)	hub max. (mm)	hub / DIN 3502 (mm)
2 ½	65	5290.720	350 894 600	1.940	2 ½	120	39	78	52
3	80	5290.800	350 894 700	2.330	3	120	45	94	56



JRG LegioStop Straight seat valve gunmetal Upper part

- Description: free of water pockets and maintenance free top, non rising handwheel with optical position indicator
- Temperature: max. 90°C
- Material: gunmetal, brass, EPDM, plastic

GN (inch)	DN (mm)	JRG Code	GF Code	Weight (kg)	d2 G (inch)	d4 (mm)	h (mm)	hub max. (mm)	hub / DIN 3512 (mm)
½	15	5395.240	350 894 800	0.125	½	53	17	10	5
¾	20	5395.320	350 894 900	0.188	¾	53	19	11	7
1	25	5395.400	350 895 000	0.330	1	60	23	13	8
1 ¼	32	5395.480	350 895 100	0.500	1 ¼	70	25	15	10
1 ½	40	5395.560	350 895 200	0.640	1 ½	90	28	17	12
2	50	5395.640	350 895 300	0.800	2	90	32	16	21



JRG LegioStop Straight seat valve Upper part DN65

- Description: free of water pockets and maintenance free top, rising handwheel
- Temperature: max. 90°C
- Material: gunmetal, stainless steel, EPDM, metal

GN (inch)	DN (mm)	JRG Code	GF Code	Weight (kg)	d2 G (inch)	d4 (mm)	h (mm)	hub max. (mm)	hub / DIN 3512 (mm)
2 ½	65	5395.720	350 895 400	1.450	2 ½	120	37	24	30

Local support around the world

Visit our webpage to get in touch with your local specialist:
www.gfps.com/our-locations



The information and technical data (altogether "Data") herein are not binding, unless explicitly confirmed in writing. The Data neither constitutes any expressed, implied or warranted characteristics, nor guaranteed properties or a guaranteed durability. All Data is subject to modification. The General Terms and Conditions of Sale of Georg Fischer Piping Systems apply.

gfps-3724362
e / 04.23 / dh
© Georg Fischer JRG AG
Hauptstrasse 130
CH-4450 Sissach/Switzerland
Telefon +41 (0) 61 975 22 22
info.jrg.ps@georgfischer.com
Printed in Switzerland